

HIPO D-Series Electrical Connector

1D37P/S - 075A



Features

- Current rating: up to 75A per contact #8
- Guiding structure to avoid mismating and floating mounting for blind mating
- Number of contacts: 37
- Contact sizes: 24x #20; 9x #12; 4x #8
- Contact length: standard, pre and post mate
- Termination: Crimp, Solder, PCB
- Plating: silver or gold

Contact information

insert arrangement	number	size	current rating	plating	termination	Fixed/Removeable
1-9	9	12#	35A	Gold oder Silber	Crimp Solder (D37-20) PCB (D37-20)	removeable removeable fixed
10-33	24	20#	5A	Gold oder Silber	Crimp Solder PCB	removeable removeable fixed
34-37	4	8#	75A	Gold oder Silber	Crimp Solder PCB	removeable removeable fixed

Pin contacts

Other platings upon request.

8# Pin

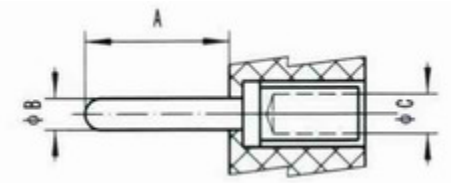
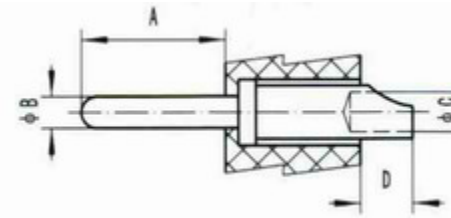
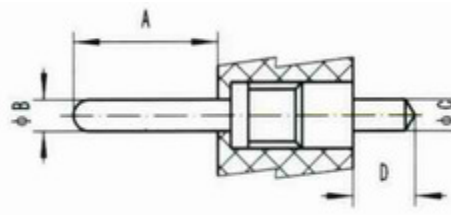
Type	Figure	termination	Dimension A	Dimension B	Dimension C	Dimension D	plating
1P8CAGPR			12.2				
1P8CAGS		Crimp	10.9	3.6	4.6	--	Ag
1P8SAGPR			12.2				
1P8SAGS		Solder	10.9	3.6	4.9	7	Ag
1P8BAGPR			12.2				
1P8BAGS		PCB	10.9	3.6	3.6	7.5	Ag

12# Pin (D29P/D37P)

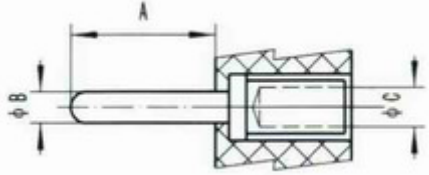
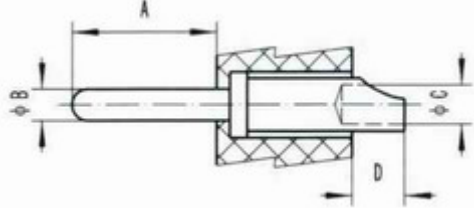
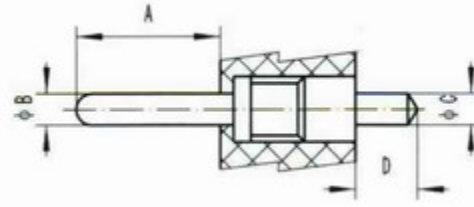
Type	Figure	termination	Dimension A	Dimension B	Dimension C	Dimension D	plating
1P12CAGPR		Crimp	11.7	2.4	2.6	--	Ag
1P12CAGS			11.0				
1P12CAGPM			10.0				
1P12SAGPR		Solder	11.7	2.4	2.6	4.3	Ag
1P12SAGS			11.0				
1P12SAGPM			10.0				
1P12BAGPR		PCB	11.7	2.4	2.4	6.0	Ag
1P12BAGS			11.0				
1P12BAGPM			10.0				

20# Pin

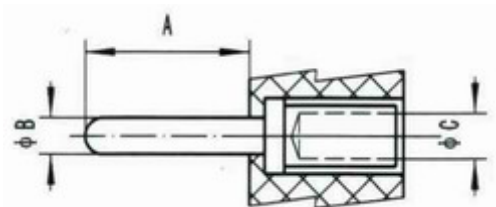
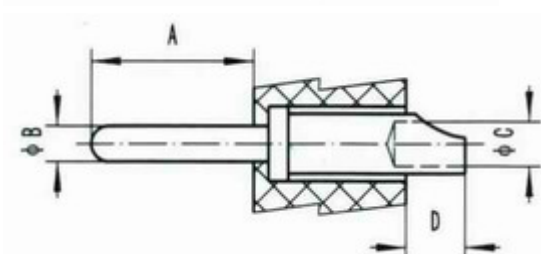
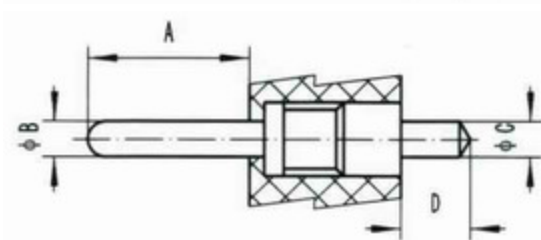
Type	Figure	termination	Dimension A	Dimension B	Dimension C	Dimension D	plating	
1P20CAUPR 1P20CAUS		Crimp	12.0 8.1 6.9	1.0	1.3	--	Au	
1P20SAUPR 1P20SAUS			Solder	12.0 8.1 6.9	1.0	1.3	4.9	Au
1P20BAUPR 1P20BAUS				PCB	12.0 8.1 6.9	1.0	1	4.7
1P20BAUPM								

Socket contacts

Other platings upon request.

8# Socket (1D37S)

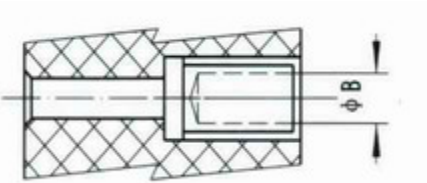
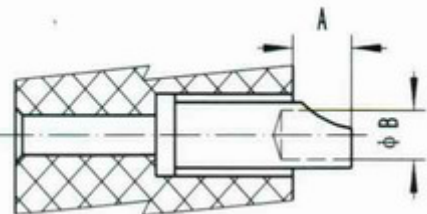
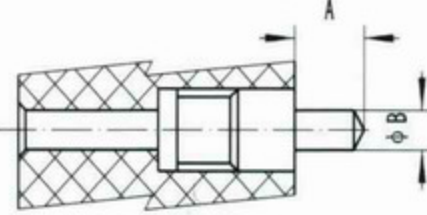
Type		Figure	termination	Dimension A	Dimension B	plating
1S8CAG-S	spring wire		Crimp	--	4.6	Ag
1S8CAG-G	crown band					
1S8SAG-S	spring wire		Solder	10.5	4.9	Ag
1S8SAG-G	crown band					
1S8BAG-S	spring wire		PCB	7	3.6	Ag
1S8BAG-G	crown band					

12# Socket (1D29S/1D37S)

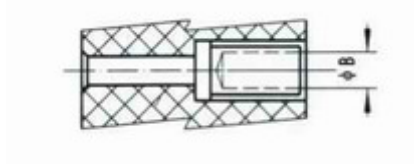
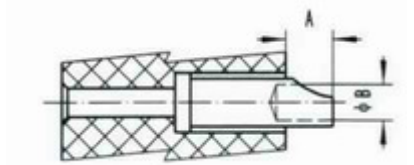
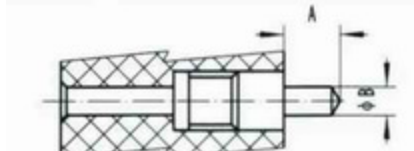
Type		Figure	termination	Dimension A	Dimension B	plating
1S12CAG-S	spring wire		Crimp	--	2.6	Ag
1S12CAG-G	crown band					
1S12CRAG *						
1S12SAG	spring wire		Solder	4.6	2.6	Ag
1S12SAG-G	crown band					
1S12SRAG *						
1S12BAG	spring wire		PCB	5.3	2.4	Ag
1S12BAG-G	crown band					
1S12BRAG *						

* suitable for hotplug

20# Socket (1D29S/1D37S)

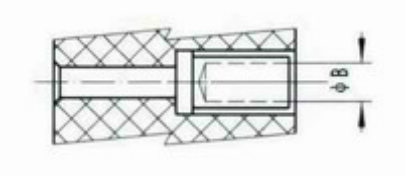
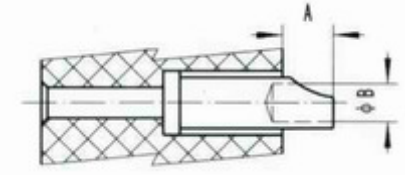
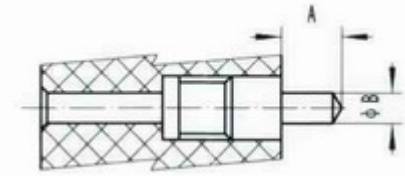
Type		Figure	termination	Dimension A	Dimension B	plating
1S20CAU-S	spring wire		Crimp	--	1.3	Au
1S20SAU-S	spring wire		Solder	4.6	1.3	Au
1S20BAU-S	spring wire		PCB	4.4	1.0	Au

1D37P
Plug Housing

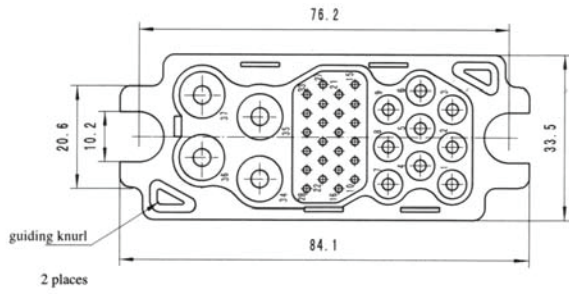

1D37S
Receptacle Housing

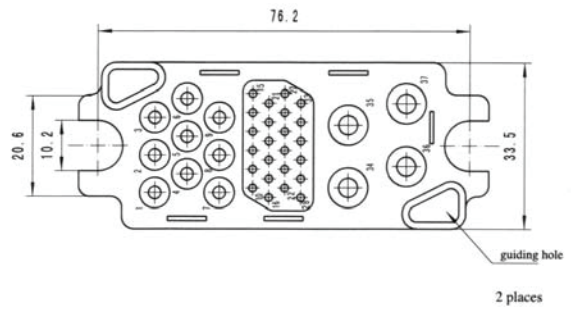

1D37P-20

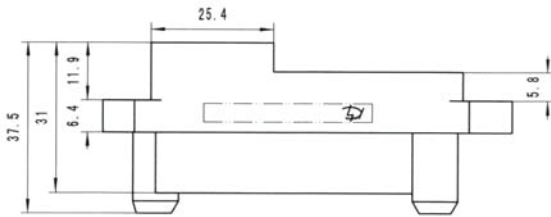

256255-01

1D37S-20

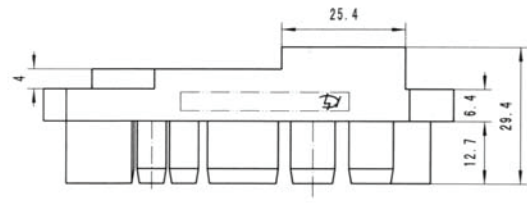

256261-01

1D37P-21

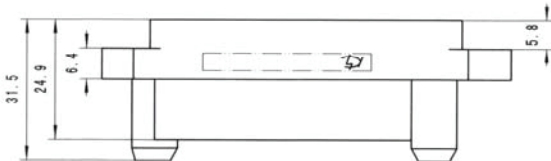

256262-01

1D37S-21

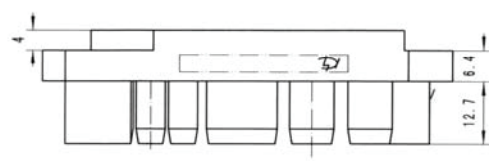

256263-01

Insert gap of plug

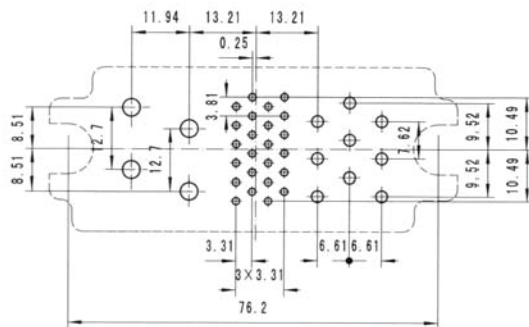

insert gap of receptacle

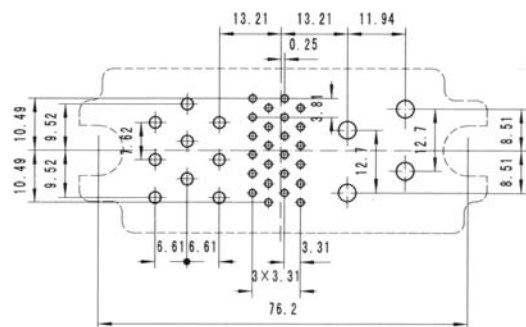

Recommend Mounting Dimension

